

EMI、EMC對策用元件

THIS SPECIFICATION IS APPLIED FOR COMMON MODE FILTERS

BCM-108050-6T4A

Product standard of spec sheet



寶仁弘電子有限公司 Prosperity Electronic Co., Limited
EML: brh@baorenhong.com Web: www.baorenhong.com
TEL: 0755-29687188 FAX: 0755-29688152
深圳市寶安區福永鎮立新二路天佑創客產業園
TEL: 0512-36878535 FAX: 0512-36878435
江蘇省昆山市花橋鎮綠地大道1325號



Note: This standard is the general industry standard, for customers' reference.

- ◆ Do not expose the products to magnets or magnetic fields.
- ◆ Use a wrist band to discharge static electricity in your body through the grounding wire.
- ◆ Carefully lay out the coil for the circuit board design of the non-magnetic shield type. A malfunction may occur due to magnetic interference.
- ◆ Soldering corrections after mounting should be within the range of the conditions determined in the specifications. If overheated, a short circuit, performance deterioration, or lifespan shortening may occur.
- ◆ When embedding a printed circuit board where a chip is mounted to a set, be sure that residual stress is not given to the chip due to the overall distortion of the printed circuit board and partial distortion such as at screw tightening portions.
- ◆ Self heating (temperature increase) occurs when the power is turned ON, so the tolerance should be sufficient for the set thermal design.
- ◆ Before soldering, be sure to preheat components. The preheating temperature should be set so that the temperature difference between the solder temperature and chip temperature does not exceed 150°C.
- ◆ Do not use or store in locations where there are conditions such as gas corrosion (salt, acid, alkali, etc.).
- ◆ The storage period is less than 12 months. Be sure to follow the storage conditions (Temperature: 5 to 40°C, Humidity: 10 to 75% RH or less).
- ◆ When designing your equipment even for general-purpose applications, you are kindly requested to take into consideration securing protection circuit/device or providing backup circuits in your equipment.
- ◆ Do not use for a purpose outside of the contents regulated in the delivery specifications.
- ◆ The products listed on this catalog are intended for use in general electronic equipment (AV equipment, telecommunications equipment, home appliances, amusement equipment, computer equipment, personal equipment, office equipment, measurement equipment, industrial robots) under a normal operation and use condition. The products are not designed or warranted to meet the requirements of the applications listed below, whose performance and/or quality require a more stringent level of safety or reliability, or whose failure, malfunction or trouble could cause serious damage to society, person or property.

◎Part Number Construction 產品描述:

BCM 108050 6T4A

BCM-----Series name 系列名稱

100805-----Dimension 產品尺寸

6T-----Impedance 阻抗值 600Ω TYP.

4A-----Current value 電流值 4A

版本: A3.2

首次承認

發行編號: CM1181043E

繪圖: 潘陽陽 小姐

審核: 羅國良 先生

核準: 魏庭 先生



REACH

◎Shape&Dimensions 形狀與尺寸:

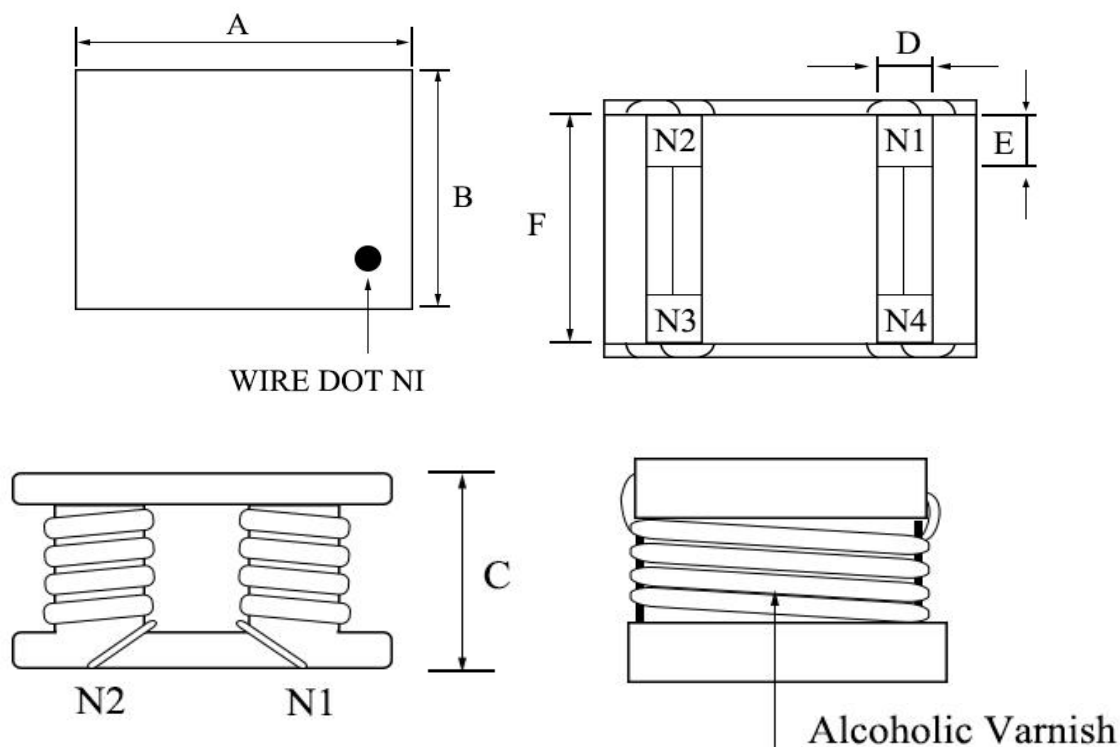

unit:mm

PART NUMBER	A	B	C	D	E	F	MPQ	MOQ
BCM 100805	10.0±0.50	8.0±0.50	5.0±0.50	1.8 Typ	1.5 Typ	7.0 REF	1 KPCS	5KPCS

◎Circuit Diagram 電路圖

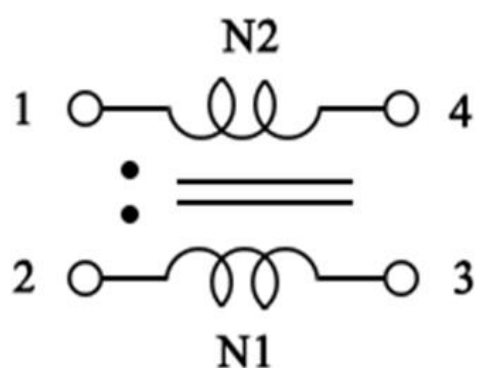

◎Electrical Characteristics 電氣特性：

Item	Spec	Test Equipment	Test Frequency
Impedance(Ω)	600 MIN	HP4286A	1KHz/25°C
DC Resistance (Ω)	0.02 MAX	CH502BC METER DCR.	
Rated Current (A)	4.0A MAX	VR126G/7220 METER IDC	
CORE SIZE	10.5*8.0*5.0		

◎ Test Data Of Preproduction Samples 樣品測試數據：

MEAS. Item	Impedance(Ω)	DC Resistance (Ω)	Product Diagram
Suggest	600 MIN	0.02 MAX	
1	672.66	0.012	
2	680.00	0.011	
3	664.00	0.010	
4	702.00	0.011	
5	663.00	0.010	
6	653.00	0.010	
7	693.00	0.010	
8	710.00	0.011	
9	702.00	0.010	
10	695.00	0.011	
— X	683.47	0.011	
R	57.00	0.002	

The test data above is only for reference, actual results may differ due to different production batches.

◎ Test Datas For Samples 樣品測試數據：

MEAS.Item	A mm	B mm	C mm	D mm	E mm	F mm
Suggest	10.0±0.50	8.0±0.50	5.0±0.50	1.8 Typ	1.5 Typ	7.0 REF
1	10.03	8.03	5.05	1.72	1.42	6.52
2	10.01	8.01	5.03	1.71	1.38	6.55
3	9.95	8.05	5.05	1.69	1.42	6.53
4	10.05	8.07	5.04	7.71	1.42	6.55
5	10.02	8.03	5.05	1.68	1.41	6.48
6	9.98	8.03	5.02	1.68	1.39	6.52
7	10.02	8.04	5.02	1.72	1.42	6.49
8	10.05	8.05	5.05	1.71	1.42	6.53
9	10.02	8.05	5.01	1.72	1.39	6.55
10	10.01	8.01	5.03	1.68	1.38	6.52
\bar{X}	10.01	8.04	5.04	2.30	1.41	6.52
R	0.10	0.06	0.04	6.03	0.04	0.07

The test data above is only for reference, actual results may differ due to different production batches.

◎The Test Curve 樣品測試曲線：

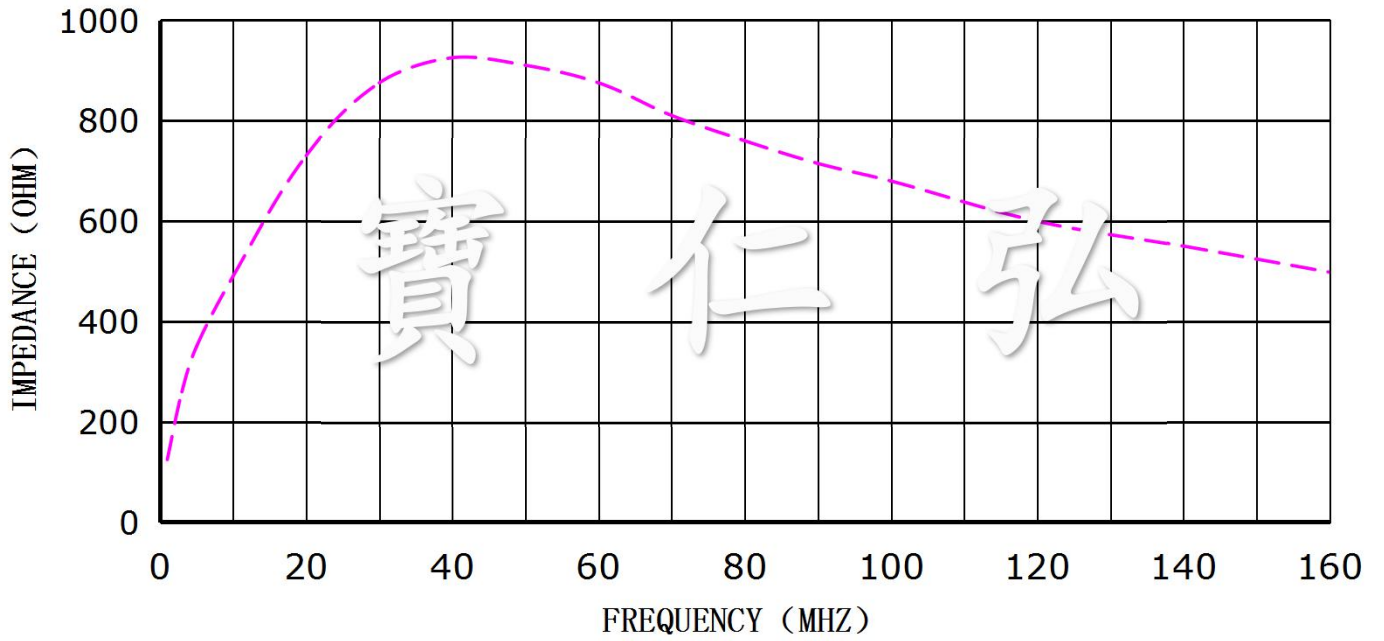

RELIABILITY AND TEST CONDITION

ELECTRICAL PERFORMANCE TEST

Operating temperature: $-40\sim+125^{\circ}\text{C}$ (Including self - temperature rise)

Storage temperature: $-40\sim+125^{\circ}\text{C}$ (on board)

RELIABILITY AND TEST CONDITION

RELIABILITY TEST

Item	Performance	Test Condition
Life Test	Appearance: No damage. Impedance: within±25% of initial value Inductance: within±15% of initial value Q: Shall not exceed the specification value. RDC: within ±15% of initial value and shall not exceed the specification value	Preconditioning: Run through IR reflow for 2 times. (IPC/JEDEC J-STD-020DClassification Reflow Profiles) Temperature: 125±2°C Applied current: rated current Duration: 1000±12hrs Measured at room temperature after placing for 24±2 hrs
Load Humidity		Preconditioning: Run through IR reflow for 2 times. (IPC/JEDEC J-STD-020DClassification Reflow Profiles) Humidity: 85±2 % R.H, Temperature: 85°C±2°C Duration: 1000hrs Min. with 100% rated current Measured at room temperature after placing for 24±2 hrs
Moisture Resistance		Preconditioning: Run through IR reflow for 2 times. (IPC/JEDEC J-STD-020DClassification Reflow) . Profiles 1. Baked at50°C for 25hrs, measured at room temperature after placing for 4 hrs. 2. Raise temperature to 65±2°C 90-100%RH in 2.5hrs, and keep 3 hours, cool down to 25°C in 2.5hrs. 3. Raise temperature to 65±2°C 90-100%RH in 2.5hrs, and keep 3 hours, cool down to 25°C in 2.5hrs,keep at 25 °C for 2 hrs then keep at -10°C for 3 hrs 4. Keep at 25°C 80-100%RH for 15min and vibrate at the frequency of 10 to 55 Hz to 10 Hz, measure at room temperature after placing for 1~2 hrs.
Thermal shock		Preconditioning: Run through IR reflow for 2 times. (IPC/JEDEC J-STD-020DClassification) Reflow Profiles Condition for 1 cycle Step1: -40±2°C 30±5min Step2: 25±2°C ≤0.5min Step3: 125±2°C 30±5min Number of cycles: 500 Measured at room temperature after placing for 24±2 hrs
Vibration		Oscillation Frequency: 10~2K~10Hz for 20 minutes Equipment: Vibration checker Total Amplitude:1.52mm±10% Testing Time : 12 hours(20 minutes, 12 cycles each of 3 orientations).

RELIABILITY AND TEST CONDITION

RELIABILITY TEST

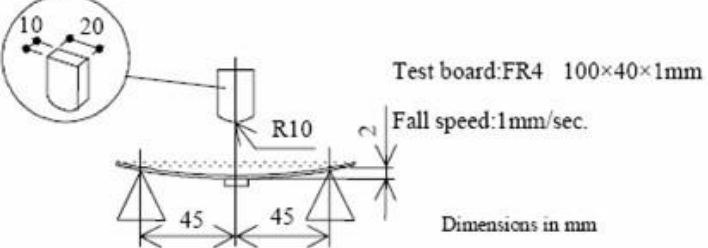
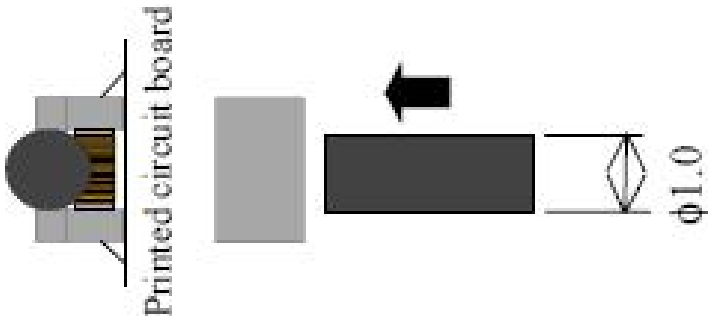
Item	Performance	Test Condition															
Strength on PC board bending	Appearance: No damage. Impedance: within $\pm 25\%$ of initial value Inductance: within $\pm 15\%$ of initial value Q: Shall not exceed the specification value. RDC: within $\pm 15\%$ of initial value and shall not exceed the specification value.	Solder a chip to test substrate and then apply a load. 															
Shock	The terminal electrode and the ferrite must not be damaged.	<table border="1" data-bbox="826 689 1533 904"> <thead> <tr> <th>Type</th> <th>Peak value (g's)</th> <th>Normal duration (D) (ms)</th> <th>Wave form</th> <th>Velocity change (Vi)ft/sec</th> </tr> </thead> <tbody> <tr> <td>SMD</td> <td>50</td> <td>11</td> <td>Half-sine</td> <td>11.3</td> </tr> <tr> <td>Lead</td> <td>50</td> <td>11</td> <td>Half-sine</td> <td>11.3</td> </tr> </tbody> </table>	Type	Peak value (g's)	Normal duration (D) (ms)	Wave form	Velocity change (Vi)ft/sec	SMD	50	11	Half-sine	11.3	Lead	50	11	Half-sine	11.3
Type	Peak value (g's)	Normal duration (D) (ms)	Wave form	Velocity change (Vi)ft/sec													
SMD	50	11	Half-sine	11.3													
Lead	50	11	Half-sine	11.3													
Solder ability	More than 95% of the terminal electrode should be covered with solder. The product shall be connected to the test circuit board by the fillet (the height is 0.2mm).	Preheat: 150°C, 60sec. Solder: Sn96.5% Ag3% Cu0.5% Temperature: 245 \pm 5°C. Flux for lead free: Rosin. 9.5%. Dip time: 4 \pm 1sec. Depth: completely cover the termination															
Resistance to Soldering Heat	Appearance: No damage. Impedance: within $\pm 25\%$ of initial value Inductance: within $\pm 15\%$ of initial value Q: Shall not exceed the specification value. RDC: within $\pm 15\%$ of initial value and shall not exceed the specification value.	Depth: completely cover the termination <table border="1" data-bbox="826 1263 1533 1473"> <thead> <tr> <th>Temperature (°C)</th> <th>Time(s)</th> <th>Temperature ramp/immersion and emersion rate</th> <th>Number of heat cycles</th> </tr> </thead> <tbody> <tr> <td>260 \pm5 (solder temp)</td> <td>10 \pm1</td> <td>25mm/s \pm6 mm/s</td> <td>1</td> </tr> </tbody> </table>	Temperature (°C)	Time(s)	Temperature ramp/immersion and emersion rate	Number of heat cycles	260 \pm 5 (solder temp)	10 \pm 1	25mm/s \pm 6 mm/s	1							
Temperature (°C)	Time(s)	Temperature ramp/immersion and emersion rate	Number of heat cycles														
260 \pm 5 (solder temp)	10 \pm 1	25mm/s \pm 6 mm/s	1														
Terminal Strength	The terminal electrode and the ferrite must not be damaged.	Solder a chip to test substrate, and then laterally apply a load 9.8N in the arrow direction. 															

COMMON MODE CHOKE

SOLDERING AND MOUNTING

- Mildly activated rosin fluxes are preferred. If hand soldering cannot be avoided, the preferred technique is the utilization of hot air soldering tools.

1.Recommended temperature profiles for re-flow soldering

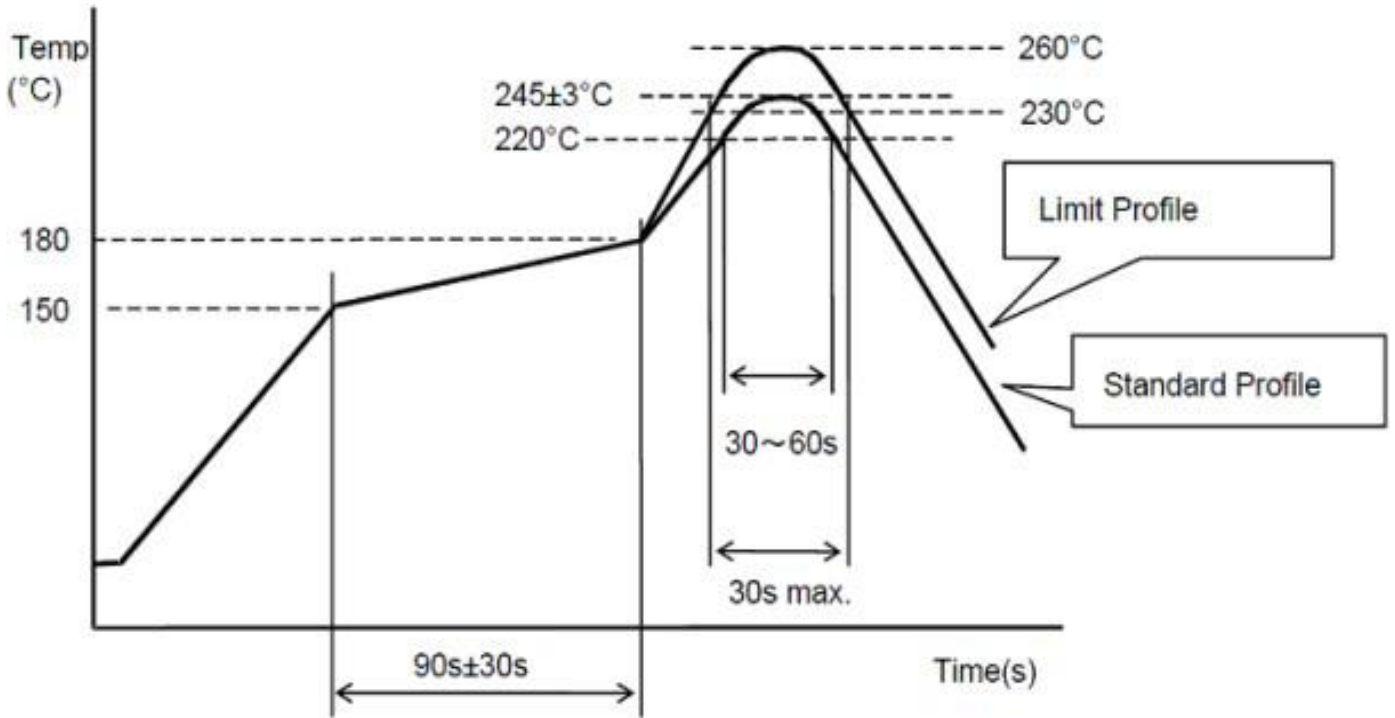

	Standard Profile	Limit Profile
Pre-heating	150~180°C 、 90s±30s	
Heating	above 220°C、 30s~60s	above 240°C、 30s max.
Peak temperature	245±3°C	260°C、 10s
Cycle of reflow	2 times	2 times

2.Flux,Solder

- Use rosin-based flux
- Don't use high acidic flux with halide content exceeding 0.2(wt)% (chlorine conversion value).
- Use lead-free solder, use Sn-3.0Ag-0.5Cu solder
- Standard thickness of solder paste: 0.12~0.15mm

3.Reworking with soldering iron

The following conditions must be strictly followed when using a soldering iron.

Pre - heating	150°C, 1 minute
Tip temperature	350°C max.
Soldering iron output	30w max.
End of soldering iron	φ 3mm max.
Soldering time	3 seconds max.

COMMON MODE CHOKE

CLEANING CONDITIONS

- **Products should be cleaned on the following conditions.**

Cleaning temperature shall be limited to 60°C max. (40°C max for fluoride and alcohol type cleaner.)	
Ultrasonic cleaning shall comply with the following conditions with avoiding the resonance phenomenon at the mounted products and P.C.B.	Power: 20 w / liter max. Frequency: 28 kHz ~ 40 kHz Time: 5 minutes max.
Cleaner	◎ Alcohol cleaner • Isopropyl alcohol (IPA)
	◎ Aqueous agent • PINE ALPHA ST – 100S
Cleaning Conditions:	Do not clean after soldering. Some cleaning agents may degrade bonding strength, and characteristics of products by detaching. If cleaning, please contact us.
There shall be no residual flux and residual cleaner after cleaning, extra flux may affect the electrical characteristics. In the case of using aqueous agent, products shall be dried completely after rinse with de-ionized water in order to remove the cleaner.	

COMMON MODE CHOKE

RESIN COATING

The impedance value may change due to high cure-stress of resin to be used for coating/molding products. An open circuit issue may occur by mechanical stress caused by the resin, amount/cured shape of resin, or operating condition etc. Some resin contains some impurities or chloride possible to generate chlorine by hydrolysis under some operating condition may cause corrosion of wire of coil, leading to open circuit. So, please pay your careful attention in selecting resin in case of coating/molding the products with the resin. Prior to use the coating resin, please make sure no reliability issue is observed by evaluating products mounted on your board.

COMMON MODE CHOKE

ASSEMBLING

<Exclusive use of Reflow soldering> Flow soldering may cause deterioration in insulation resistance.

So, reflow soldering shall be applied for this product.

COMMON MODE CHOKE

ATTENTION REGARDING P.C.B BENDING

The following shall be considered when designing and laying out P.C.B.

P.C.B shall be designed so that products are not subjected to the mechanical stress due to warping the board.

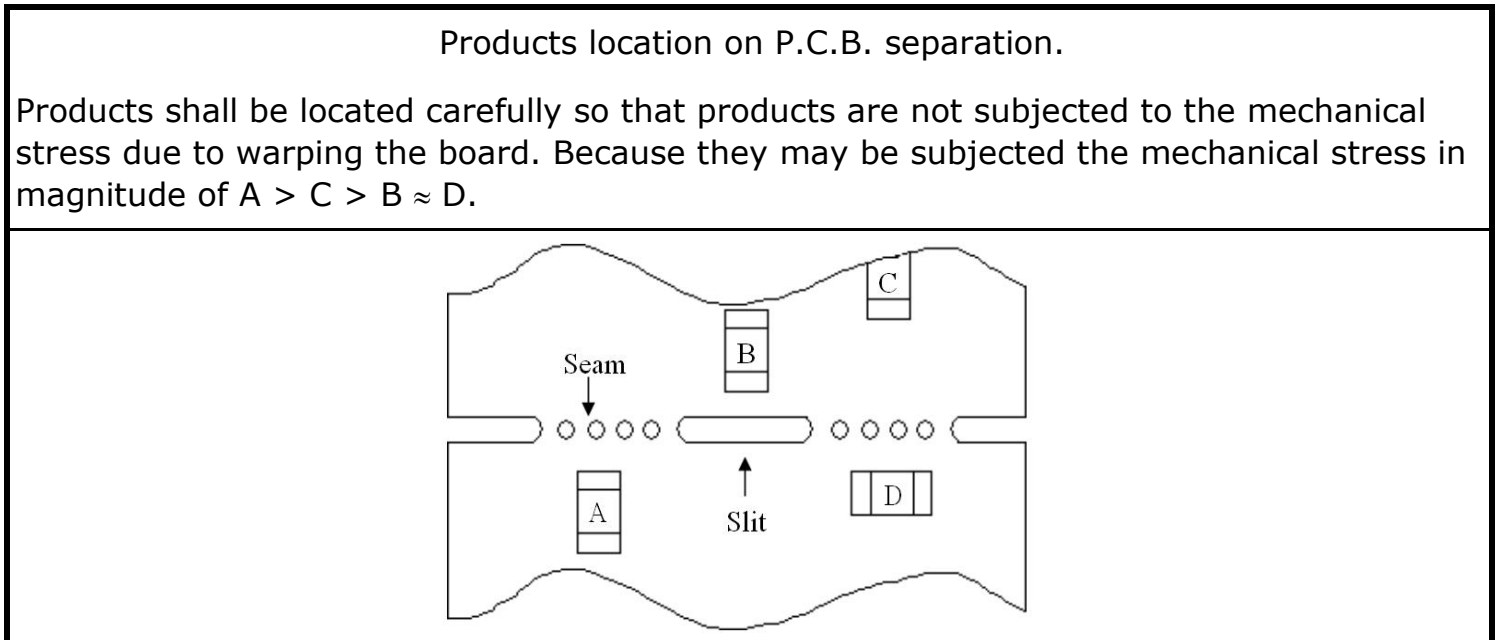
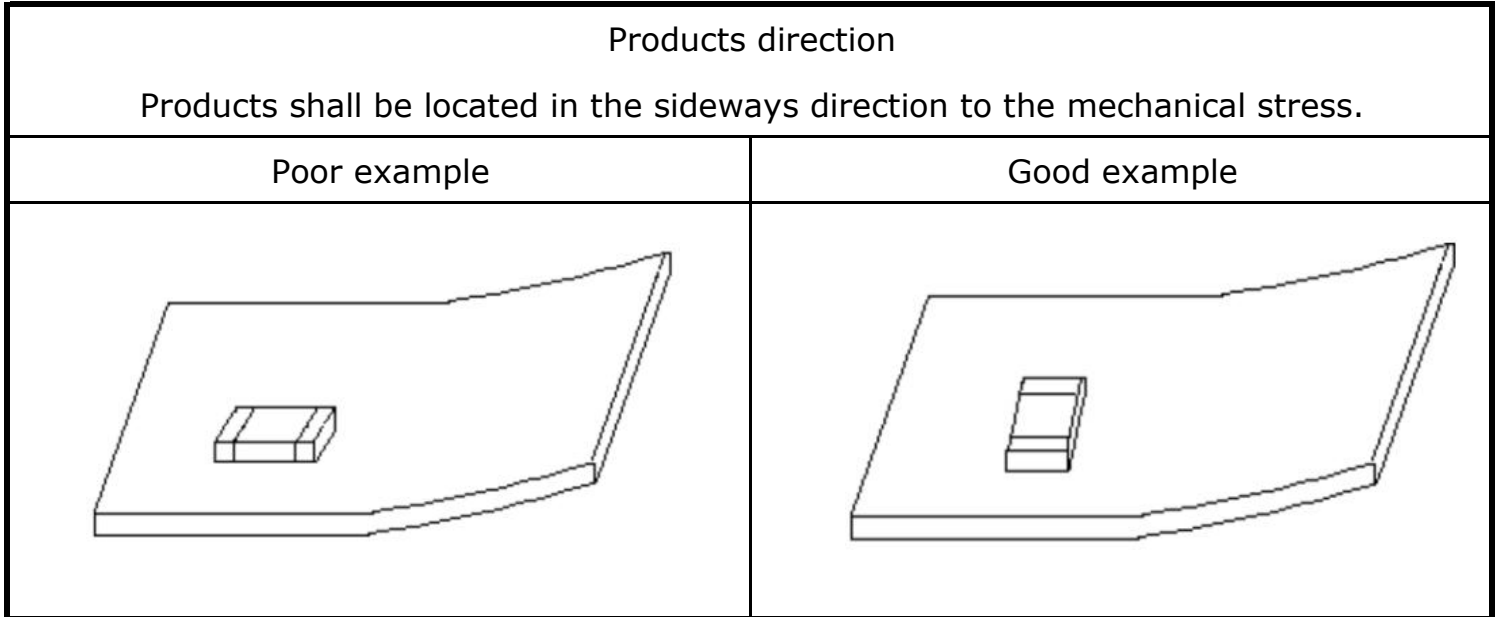

COMMON MODE CHOKE

RESIN COATING

The electrical characteristics may be changed due to the large cure-stress of the resin to be used for coating/molding products. Some resin contains some impurities or chloride possible to generate chlorine by hydrolysis under some operating condition may cause corrosion of wire of coil ,leading to open circuit. So please pay your careful attention in selecting resin to prevent any affection on the product in case of coating/molding the products with the resin. In prior to use,please make the reliability evaluation with the product mounted in your application set.

COMMON MODE CHOKE

CAUTION FOR USE

Limitation of Applications

Please contact us before using our products for the applications listed below which require especially high reliability for the prevention of defects which might directly cause damage to the third party's life, body or property.

1. Aircraft equipment
2. Aerospace equipment
3. Undersea equipment
4. Power plant control equipment
5. Medical equipment

Requirements to the applications listed in the above.

6. Transportation equipment (vehicles, trains, ships, etc.)
7. Traffic signal equipment
8. Disaster prevention / crime prevention equipment
9. Data-processing equipment
10. Applications of similar complexity and / or reliability

There is possibility that the inductance value change due to magnetism. Don't use a magnet or a pair of tweezers with magnetism when chip coil are handled. (The tip of the tweezers should be molded with resin or pottery.)

Sharp material, such as a pair of tweezers, shall not be touched to the winding portion to prevent the breaking of wire.

Mechanical shock should not be applied to the products mounted on the board to prevent the breaking of the core.

COMMON MODE CHOKE

STORAGE AND HANDLING REQUIREMENTS

Storage period

Products should be used in 6 months from the day of PROSPERITY ELECTRONICS CO.,LTD outgoing inspection. Solderability should be checked if this period is exceeded.

Storage conditions

Products should be storage in the warehouse on the following conditions.

Temperature : 0 ~ 40°C

Humidity : 55 ~ 70% relative humidity

No rapid change on temperature and humidity

Don't keep products in corrosive gases such as sulfur, chlorine gas or acid, or it may cause oxidation of electrode, resulting in poor solderability.

Products should be stored on the palette for the prevention of the influence from humidity, dust and so on.

Products should be stored in the warehouse without heat shock, vibration, direct sunlight etc.

Products should be stored under the airtight package condition.

Handling Condition

Care should be taken when transporting of handling product to avoid excessive vibration or mechanical shock.

◆ **Tape Dimensions And Packaging Quantities :**

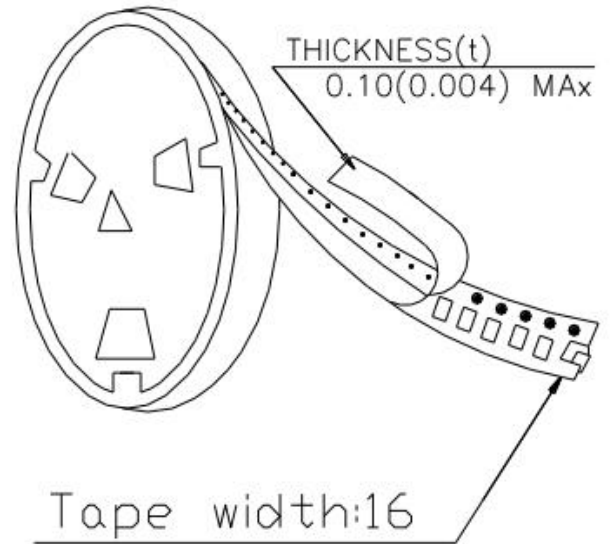
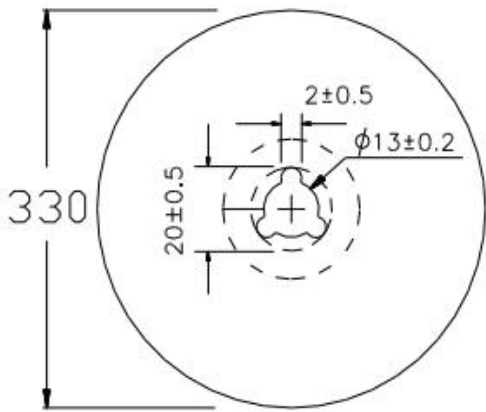

The force for tearing off cover tape is 15 to 130 grams in the arrow direction

